

SWIMMING POOLS AND TERRACES CONSTRUCTION AND REHABILITATION



NEW BUILD POOLS

Important construction information for making the tank	4 - 6
Building a pool with system 9, step by step	7 - 11
Position of accesories in swimming pools	12
Installing the ceramic rungs in pools	13
<hr/>	
Execution Specifications	
the correct way to build a swimming pool	14
the correct construction of a private swimming pool without waterproofing	15

RENOVATING POOLS

Conversion of a skimmer pool to a deck level pool	16 - 19
<hr/>	
Execution Specifications	
Renovating a pool without removing the old covering	20
Renovating a stainless steel swimming pool or spa	21
Renovating a polyester pool	22
Renovating a pool lined with pvc sheeting	23

POOL DECK AREA AND TERRACES

Important construction issues in the execution of a terrace	24 - 29
Flooring safety: anti-slip	30 - 31
Cleaning: cleaning protocol for anti-slip products	32 - 33
Installing the water collection gutter	34
<hr/>	
Execution Specifications	
Waterproofing of the terrace and pool deck	35



This brochure aims to set out the most important building tasks in the execution of a terrace and a swimming pool in this guide, whether for a new build or a renovation.

We also offer some practical fact sheets for carrying out this work, which will be of great help to professionals.

This brochure is a tool to assist builders and fitters, who will find new and unique solutions that will save on costs and help avoid pitfalls.

It has been developed thanks to ROSAGRES and FIXCER deep knowledge of the construction site. Together they have set out quality solutions for construction to ensure the proper execution of works and a perfect finish. More specifically, they suggest comprehensive solutions to ensure your project is a success.

It is not intended to be a concise building manual. We expect professionals to know their job and the specific peculiarities of each project.

Rosa Gres and Fixcer have an ongoing research programme that is conducted by a highly qualified team of technicians, seeking to offer advanced technical solutions for sustainable construction.

For any queries about ceramic materials contact:
tecnic@rosagres.com

For any queries about fixing products contact:
fixcer@fixcer.com



**ROSA
GRES**

Rosa Gres is a manufacturer of ceramic tiles and coverings, specialising in outdoor paving terraces and pools, with projects throughout the world and with more than 40 years' expertise.



Fixcer is a manufacturer of chemical products for construction. It is a specialist in materials to attach high quality ceramic tiles, such as porcelain tiles, and in solutions to renovate pools. It celebrates its 20th anniversary.

Note: the fixing mortars and grouts recommended in this catalogue, are accompanied by their classification according to European standards EN 12004 and EN 13.888 respectively in the explanations.

1 MEASUREMENTS



When deciding on the final distance between the concrete walls, take into account the fact that the waterproofing, the screed, the cement glue and the ceramic tile are approximately 3.5 cm (1.37") thick at each of the walls. Therefore if the finished pool must be 25m, the distance between walls cannot be less than 25.07 m.

For competition pools, an additional 1.5 cm should be taken into account to place the touchpads. Therefore, if we are trying to standardise a 25m pool, this should have a distance of 25.03m between both ends.

NOTE: If using S9 blocks, plan enough space for them and the mortar.

2 WATERTIGHTNESS



The watertightness **must be guaranteed by the concrete tank**. Any waterproofing treatment is only an additional guarantee of watertightness. Therefore the concrete used must be waterproof.

One way of ensuring a pool is watertight is to use an expansive joint, such as **FUGA-STOP**, on the wall-floor, wall-wall and concrete joints before pouring the concrete. When **FUGA-STOP** comes into contact with the water, it reacts by expanding and containing any leaks.

A watertightness test must be carried out when the concrete tank is complete. The pool should then be filled and checked for leaks over a period of two to three weeks.

3 PREPARING THE SURFACES: SCREEDS



Eliminate any dust or oil residue from the concrete

To ensure the adhesion of the mortar:

Apply a bonding paste made of 1:1 **PRIMFIX** latex, for example, and Portland cement. Apply with a brush. This bond ensures adhesion between the concrete and the screed.

Use a screed mix that is specifically formulated to be used in swimming pools. The **FIX-REVOCO** mortar for walls and the **RECREM PRE-MIX** mortar for floors are formulations containing clean silica sands, devoid of expansive clays, slags, etc. They are very easy to use with everyday tools and have the added advantage of being quick-setting.

4 WATERPROOFING AND LAYING THE CERAMIC TILES



Concrete undergoes structural movements due to pressure, compression and shrinkage throughout its life cycle. These small movements can compromise the watertightness of pools. One simple, inexpensive way of applying a second watertight seal is by waterproofing the walls, floor, overflow outlet and channel using the elastic mortar **HIDROELASTIC**, for example. After a couple of days, lay the ceramic tiles with **TECNO-COL FLEX** (a C2 TS1 cement, suitable for bonding over waterproof layers) and a 10 mm notched trowel. We recommend using the double bonding technique.

If owing to budget constraints it is not possible to apply an extra waterproofing, set the tiles directly on the screed mortar. Once this mortar is cured and dry, set the tiles using **FIXAGRES FLEX** cement. Use a 10 mm notched trowel. We recommend using the double bonding technique.

5 DISTRIBUTION OF POOL COMPONENTS BEFORE INSTALLATION MARKING THE POOL

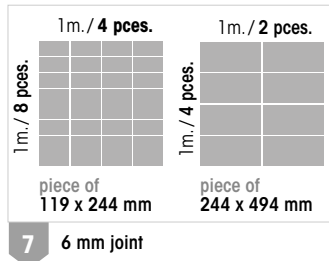

- 1** Place the special corner pieces, according to the type of perimeter edge chosen, in the four corners. Fig. 1
- 2** Draw marks every linear metre around the whole perimeter, using the corner pieces as a starting point. Fig. 2
- 3** A piece can be placed every linear metre to a serve as a guide.
- 4** Mark coloured vertical lines down the side of the walls (blue marking paint or similar). Fig. 3
- 5** The lines are squared in line with the base. The tank will therefore form a grid pattern and serve as a perfect guide for laying the ceramic pieces. Fig. 4
- 6** If necessary, mark the lines for the lanes on both the walls and the bottom of the pool.
- 7** Place the **119x244 parts format 119x244** in a ratio of 4 pieces per linear metre lengthways and 8 pieces across. The **244x494 ones** are placed in a ratio of 2 pieces per linear metre lengthways and 4 pieces across. In both cases the joint between pieces will be approximately 6 mm.

6 STARTING THE TILING

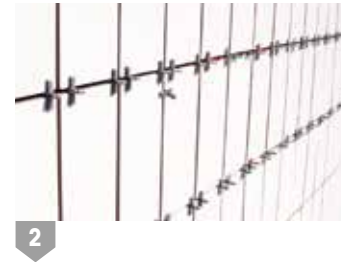

- 1** Begin tiling the walls following the coloured lines previously marked.
- 2** Cross-pieces can be used on the verticals, inserting them between the pieces as shown in the photograph.
- 3** Once all the walls have been tiled, place the parts on the bottom of the tank.
- 4** Cross-pieces do not need to be used for the flooring as final adjustment of the pieces can be carried out by hand, always following the lines.

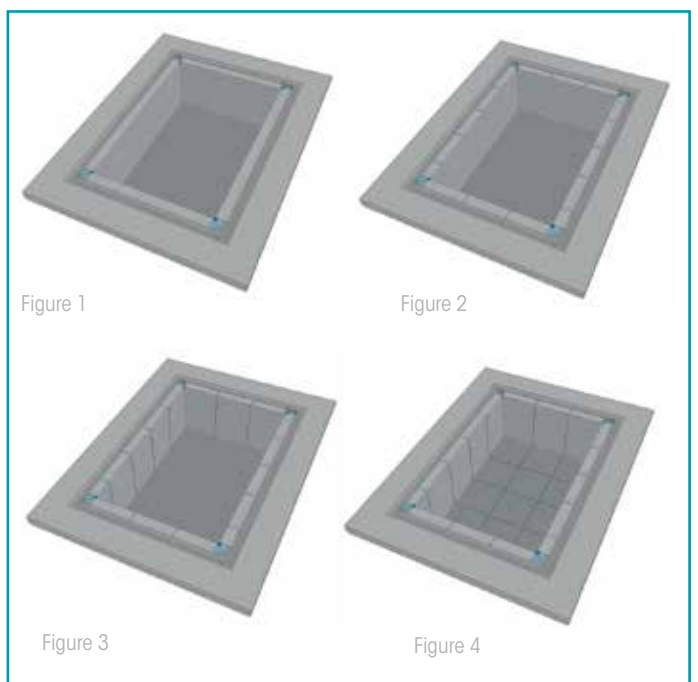

7 WATERPROOF GROUT



Another way of improving the watertightness of the tank is to use a fully watertight, flexible and acid-proof mortar such as **CERPOXI**.

The **JUNTATEC** coloured mortar is a very good alternative. It is resistant to weak acids and has a residual absorption value of just 2%.

NOTE: Wait for 5-7 days before filling with water.

8 EXPANSION JOINTS



The structural joints of the pool, if any, have to be respected and place expansion joints every 25 square metres and/or 5 linear metres, as a maximum.

For the sealing, use **SELLALASTIC FOAM** as grouting and **SELLASTIC** elastic filler as the final sealing. Wait for 5-7 days before filling pool.



CLEANING GROUT RESIDUE

Only in the case of very encrusted residue, use:

- If we have used **JUNTATEC**: after a minimum of 3 days have passed, we should use an acid cleaner, such as **GRESNET**, diluted with water in an acid:water ratio of 1:10.
- If we have used **CERPOXI**: after 24 hours have passed, we should clean it with a special paint stripper, such as **EPOXI CLEANER**, to remove any remains.

OPEN-AIR POOL RECOMMENDATIONS

TYPE OF CERAMIC TILES TO LAY

Always use porcelain stoneware tiles.

EXPANSION JOINTS EXPANSION JOINTS

These are particularly necessary in open-air pools. The whole tank should be squared with expansion joints in sections of 25 square metres and/or 5 linear metres as a maximum. In the area of the upper edge of the pool, the expansion joints should be placed at every linear metre.

WATER LEVEL

The pool should never be emptied in winter. The water level should be maintained at the level of the overflow drain. The water acts like a thermal pillow, absorbing the expansion and contractions due to changes in temperature.

ICE

To avoid pressure from ice against the walls, there should be elastic components (such as tyres, sponges, spongy plastics, porexpan...) floating in the pool next to the sidewalls.

THERMAL COVER

Recommended to protect the pool during winter

System 9 is a pre-fabricated coping system. It comprises of a set of water-repellent concrete blocks designed so that a singlepiece acts as a drainage channel and tile support.

THE 9 ADVANTAGES OF S9

1. Reduces the costs of the concrete overflow system construction.
2. Speeds up the installation processes, saving time and labour.
3. Facilitates the layout of the parts as they have been designed to favour the installation process.
4. Improves the top finish of the concrete gunite walls.
5. Avoids the shortcomings that are often present as a result of the formwork.
6. Guarantees a perfect finish of the swimming pool brim.
7. Offers an aesthetically pleasing finish. The visual presentation of the perimeter once the pool is built is linear and uniform.
8. Offers a complete series of specialised parts. A solution for every detail: stair niches, corners, cork float line anchorage among others.
9. Has been designed to be complimented by Rosa Gres modular ceramic tiles.

ERGO SYSTEM - Ref. RS 901 block

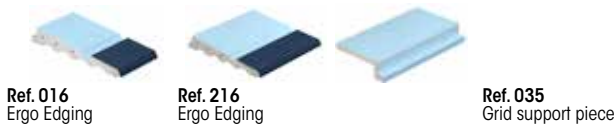
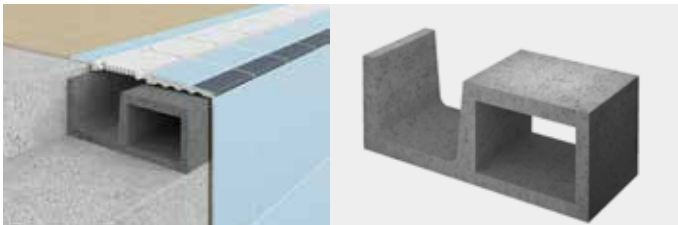

Check available colours in the Perfect Pools catalogue. 7 colours to choose from.

FINNISH SYSTEM - Ref. RS 911 block



Check available colours in the Perfect Pools catalogue. 7 colours to choose from.

PRESTIGE SYSTEM - Ref. RS 921 block



Check available colours in the Perfect Pools catalogue. 21 colours to choose from.

HORYZON SYSTEM - Ref. RS 911 block



Check available colours in the Perfect Pools catalogue. 7 colours to choose from.

S9 WIESBADEN SYSTEM - Ref. RS 941 block

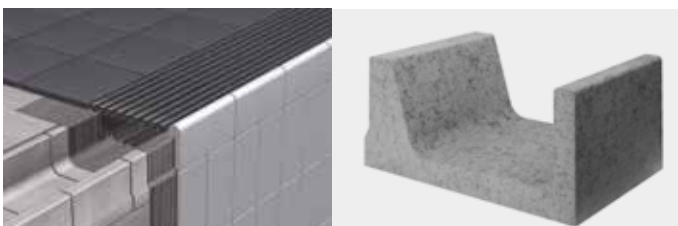

Check available colours in the Perfect Pools catalogue. 7 colours to choose from.

SPA SYSTEM - Ref. RS 931 block

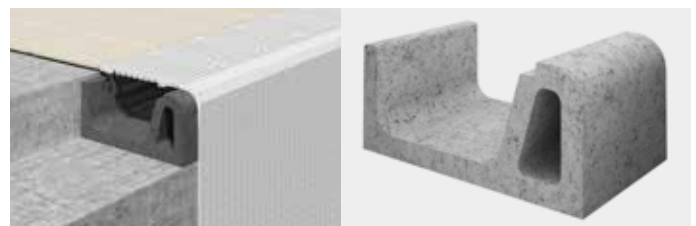

Check available colours in the Perfect Pools or Unique Pools catalogue.

ERGO
SYSTEM

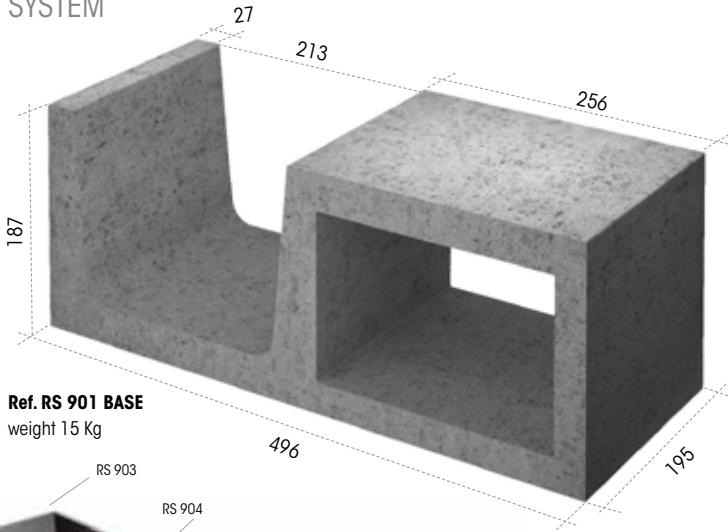

Ref. RS 901 BASE
weight 15 Kg

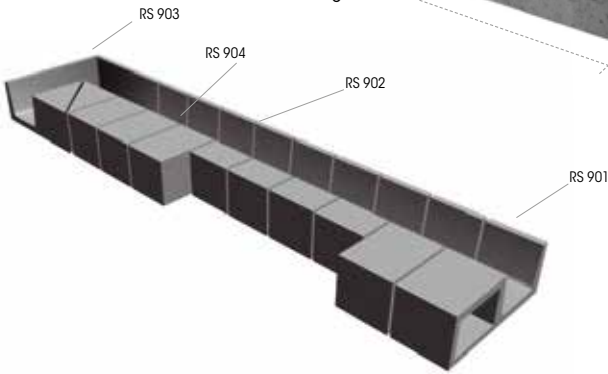

Ref. RS 901 BASE

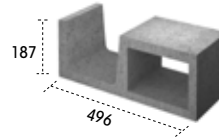

Ref. RS 904 SOLID

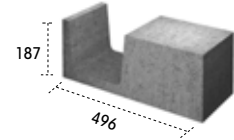

Ref. RS 902 OPEN WILT-IN STEPS

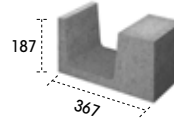

Ref. RS 905 CLOSED STEPS

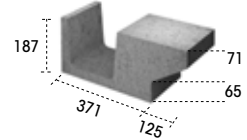

Ref. RS 903 INSIDE CORNER

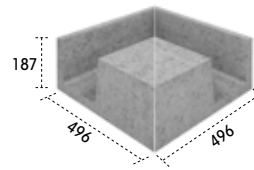

Ref. RS 908 OUTSIDE CORNERS

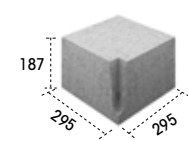

FINLANDES
SYSTEM

HORYZON
SYSTEM

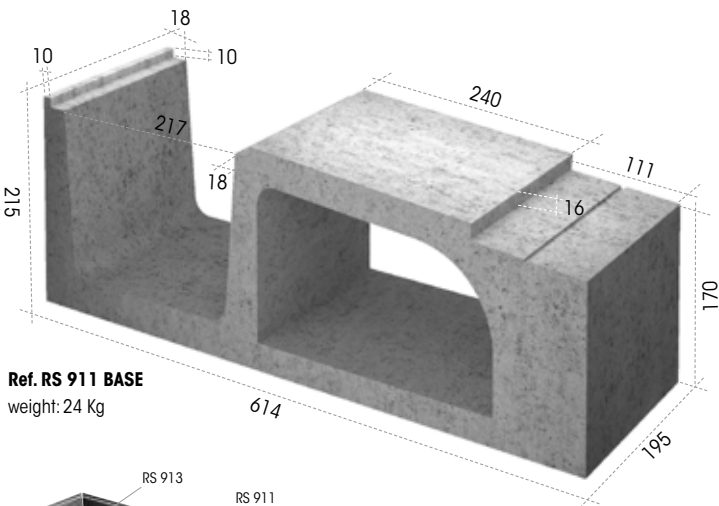

Ref. RS 911 BASE
weight: 24 Kg

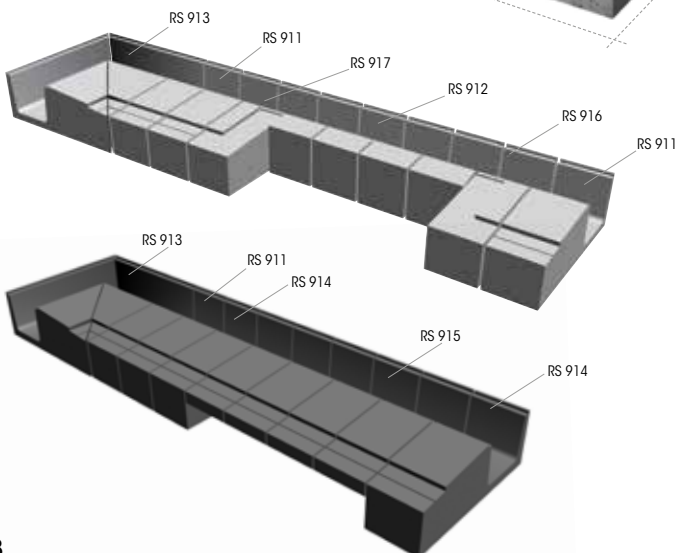

Ref. RS 911 BASE

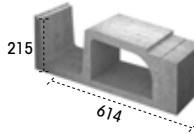

Ref. RS 915 CLOSED STEPS

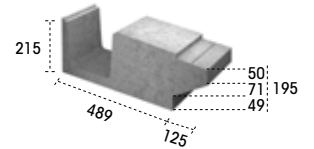

Ref. RS 912 OPEN BUILT-IN STEPS

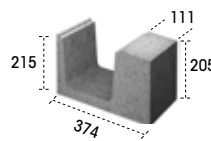

Ref. RS 916 RIGHT OPEN STEPS

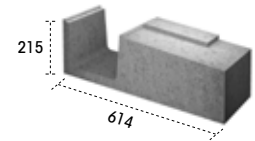

Ref. RS 913 INSIDE CORNER

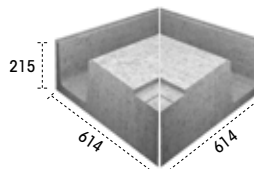

Ref. RS 917 LEFT OPEN STEPS

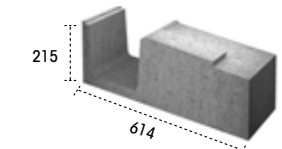

Ref. RS 914 SOLID

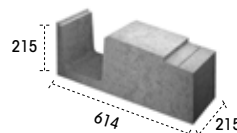

Ref. RS 918 OUTSIDE CORNERS

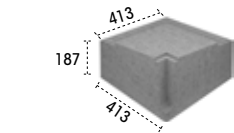

PRESTIGE SYSTEM

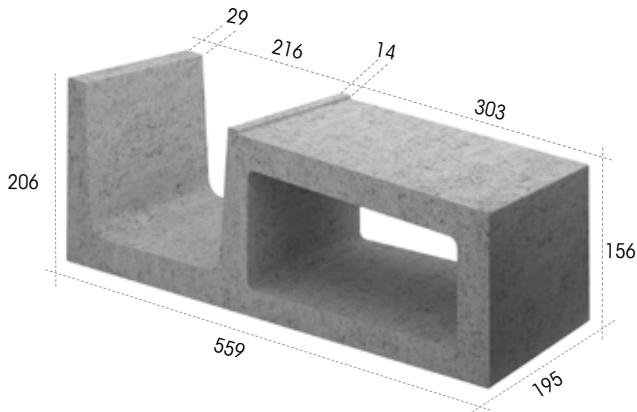

Ref. RS 921 BASE
weight: 20 Kg

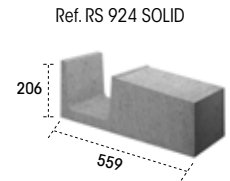
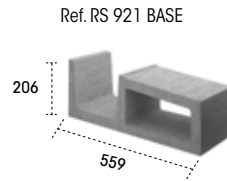

Ref. RS 922 OPEN WITH-IN STEPS

Ref. RS 928 OUTSIDE CORNERS

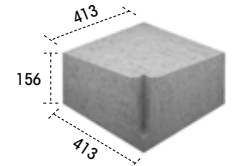
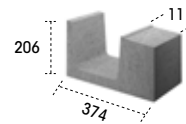

Ref. RS 923 INSIDE CORNER

Ref. RS 925 CLOSED STEPS

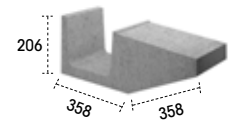
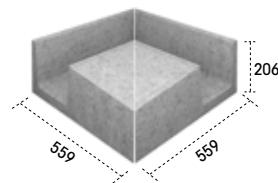

SPA SYSTEM

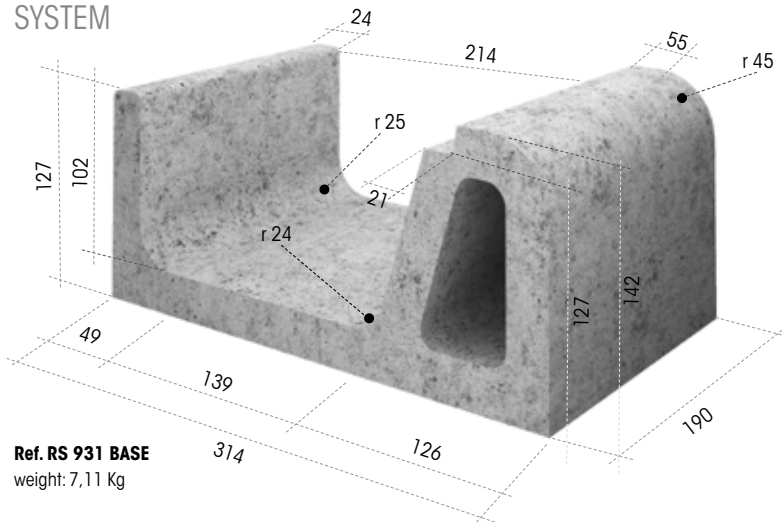

Ref. RS 931 BASE
weight: 7,11 Kg

Ref. RS 931 BASE

Ref. RS 938 OUTSIDE CORNER

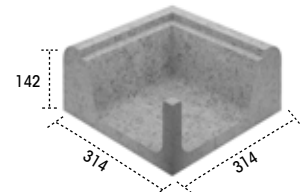
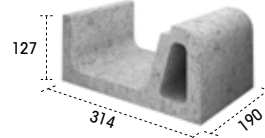

Ref. RS 933 INSIDE CORNERS

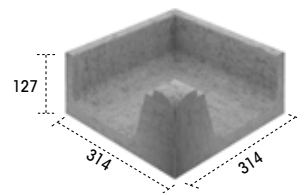

S9 WIESBADEN SYSTEM

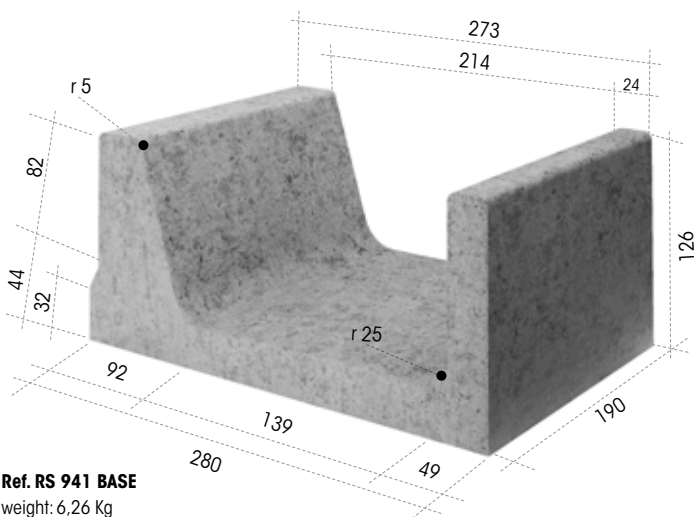

Ref. RS 941 BASE
weight: 6,26 Kg

Ref. RS 941 BASE

Ref. RS 948 OUTSIDE CORNERS

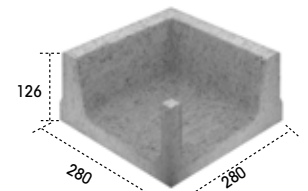
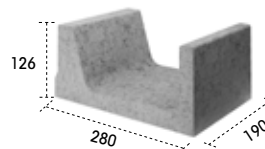

Ref. RS 943 INSIDE CORNER

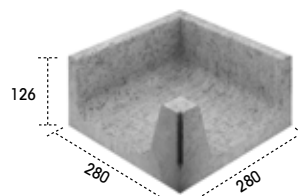



The concrete is cast, forming the walls, tank bottom and perimeter low wall, leaving a reception area for laying the S9 block according to its measurements.



To simplify the process of concreting, this may be done in two stages. First a flat reception area is left with some reinforced iron bars and we place the hydro-expansive joint **FUGA STOP MINI** in the middle of the reinforced bars. Then it is finished by filling the gap (after step 5).



We start by positioning the pieces of the corners using a laser level. We place twine between them. Then we position the S9 blocks between corner and corner.



The concrete blocks are positioned with mortar to which a latex type additive such as **PRIMFIX** has been added with 1 part **PRIMFIX** to 2 parts water.



It is also essential to place mortar in the joint between the blocks. Once the blocks have been positioned the back gap is filled with concrete.



Using the blocks as a guide, the mortar screed from the walls is made with a mortar of uniform quality and quick drying such as **FIX-REVOCO**.

7

The waterproofing of the tank is carried out with an elastic type of waterproofing, such as **HIDROELASTIC**, on which the tiles will be placed on top. And the waterproofing of the channel is done using a waterproofing such as **HIDROFIX**.

8

Laying the ceramic tiles: use an adhesive cement type C2T S1 suitable for adhering the porcelain stoneware on top of waterproofing, such as **TECNOCOL FLEX**.



System 9 can be used for both straight and curved swimming pools.

LAYING DETAILS

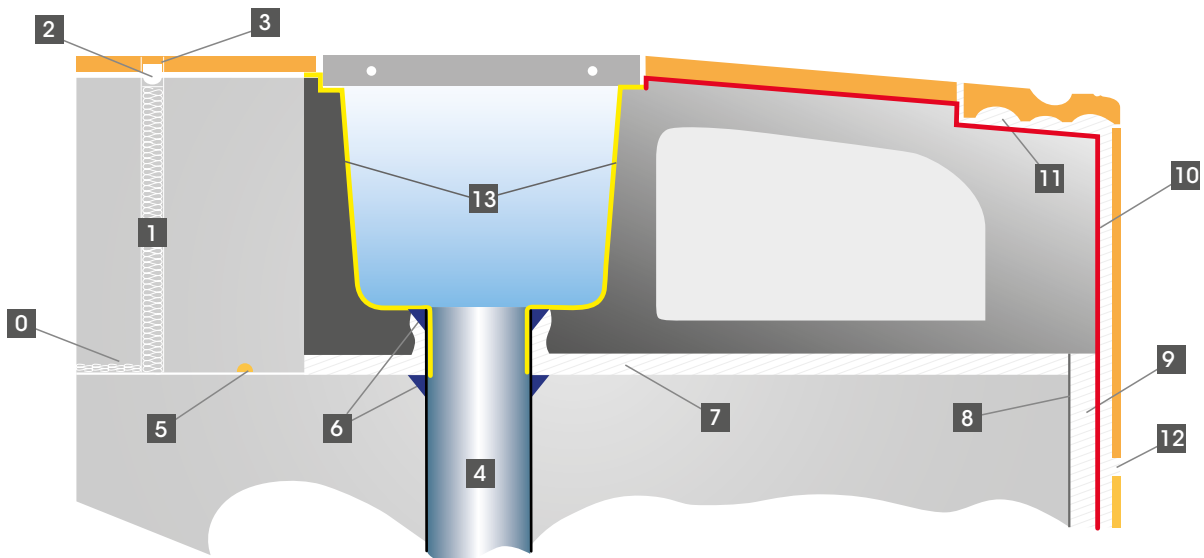

0 Working seal

1 Expansion joint essential perimeter throughout the entire pool

2 Base of joint. Strip of (**SELLALASTIC POLYETHYLENE FOAM**)

3 Elastic filler for expansion joints (**SELLALASTIC**)

4 Drainage recommended approx every 4 m.

5 Hydro-expansive joints (**FUGA-STOP MINI**)

6 Watertight sealing (**SELLADOR S10**)

7 Glue mortar + **PRIMFIX** + water

8 **PRIMFIX** + **PORTLAND JOINT** (1:1)

9 Screed mortar such as **FIX-REVOCO**

10 Waterproofing (**HIDROELASTIC**)

11 Cement-glue specially for non-absorbant surfaces **TECNOCOL FLEX**

12 Mortar for grouting. **JUNTATEC**

13 Waterproofed channel with **HIDROFIX** mortar

NOTE: Before applying the **S10 SEAL**, rub the pipe with PVC solvent; apply the **S10 SEALING** primer on the concrete; wait between 1h-4h and apply the **S10 SEALING** pressing against the PVC and Concrete.

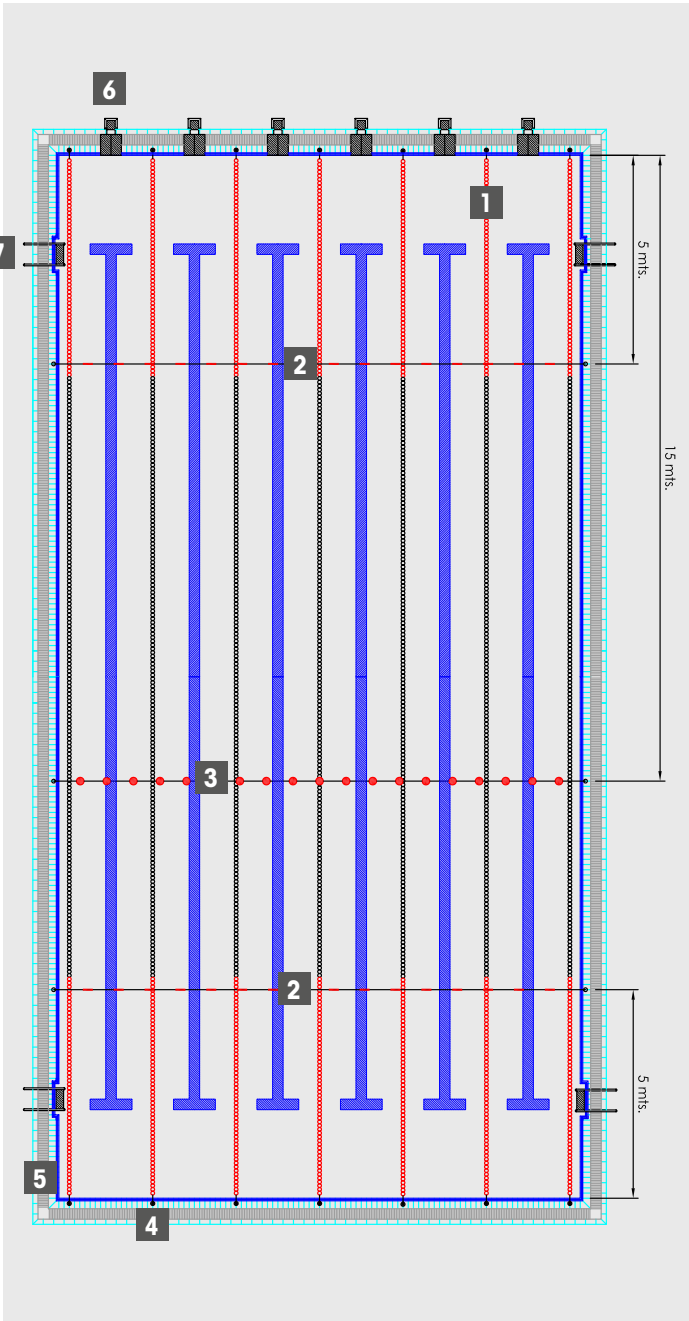
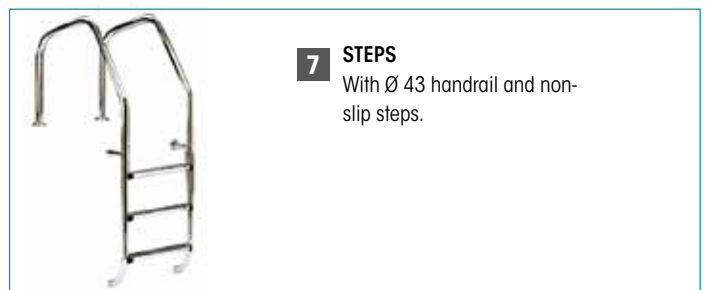
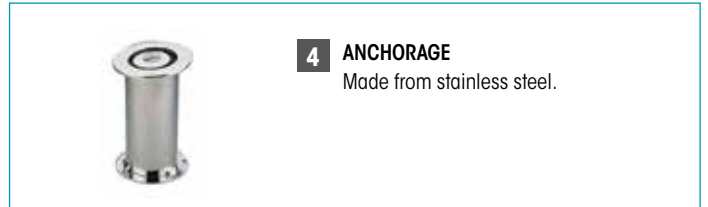
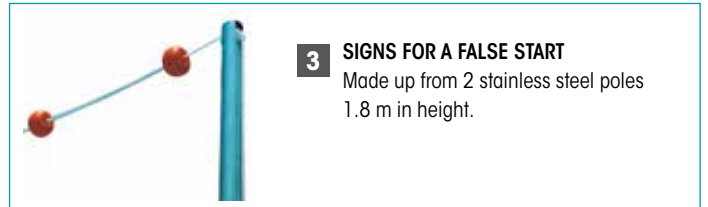
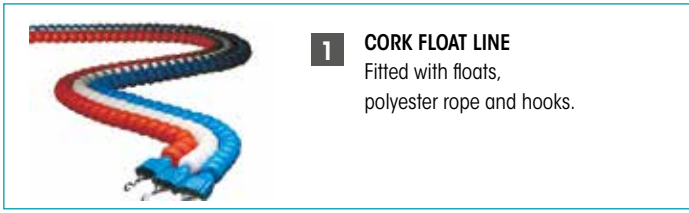

CORK FLOAT LINE SIZES

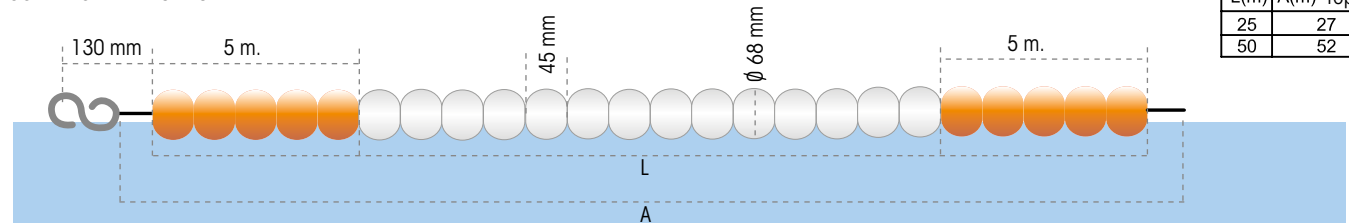

L(m)	A(m)	rope
25	27	
50	52	

1 Insert a rod (preferably stainless steel) through each of the holes of the step Ref. 019 making them protrude at both ends.

2 Fill the gaps in the blocks with non-shrink **GROUT S10** mortar placing 6 mm cross-pieces between them.

3 Align and allow to dry.

4 If an insertion groove of the tank has not been planned on site, dig to open one up.

5 Place the rungs in their position.

6 Cover the insertion groove holes with epoxy mortar such as **EPOXICOL**.

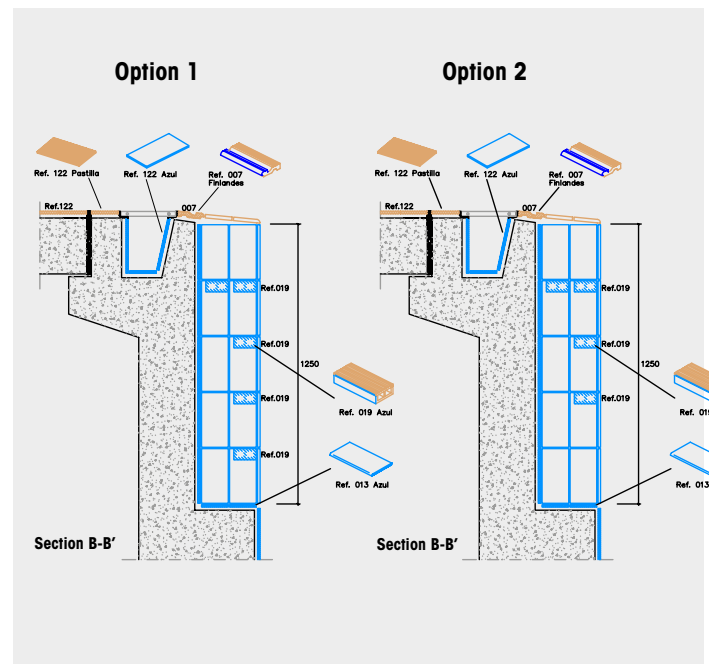
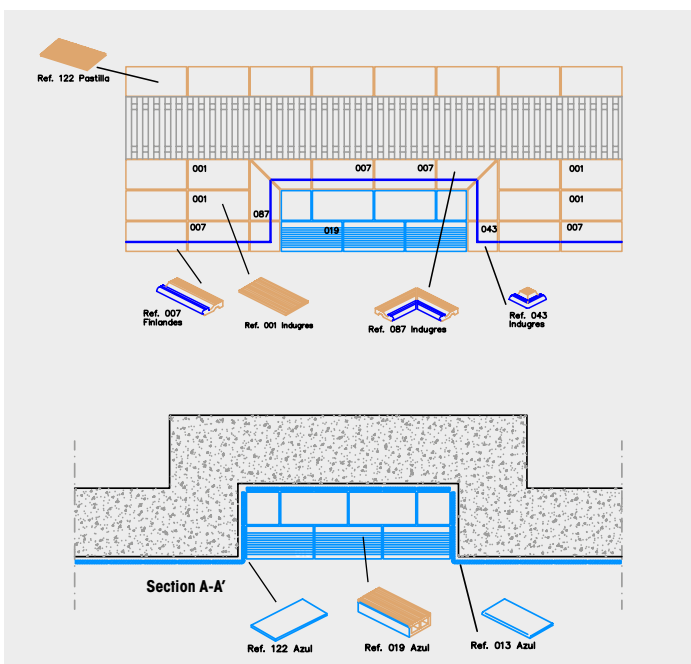
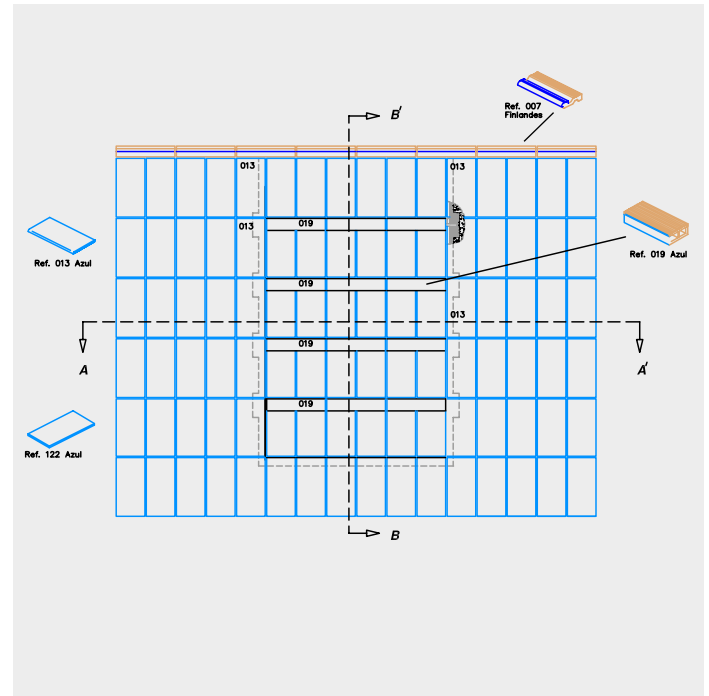

Technical solution to correctly build your pool properly at all stages: seals, sealing, screeds, waterproofing, bonding, grouting.

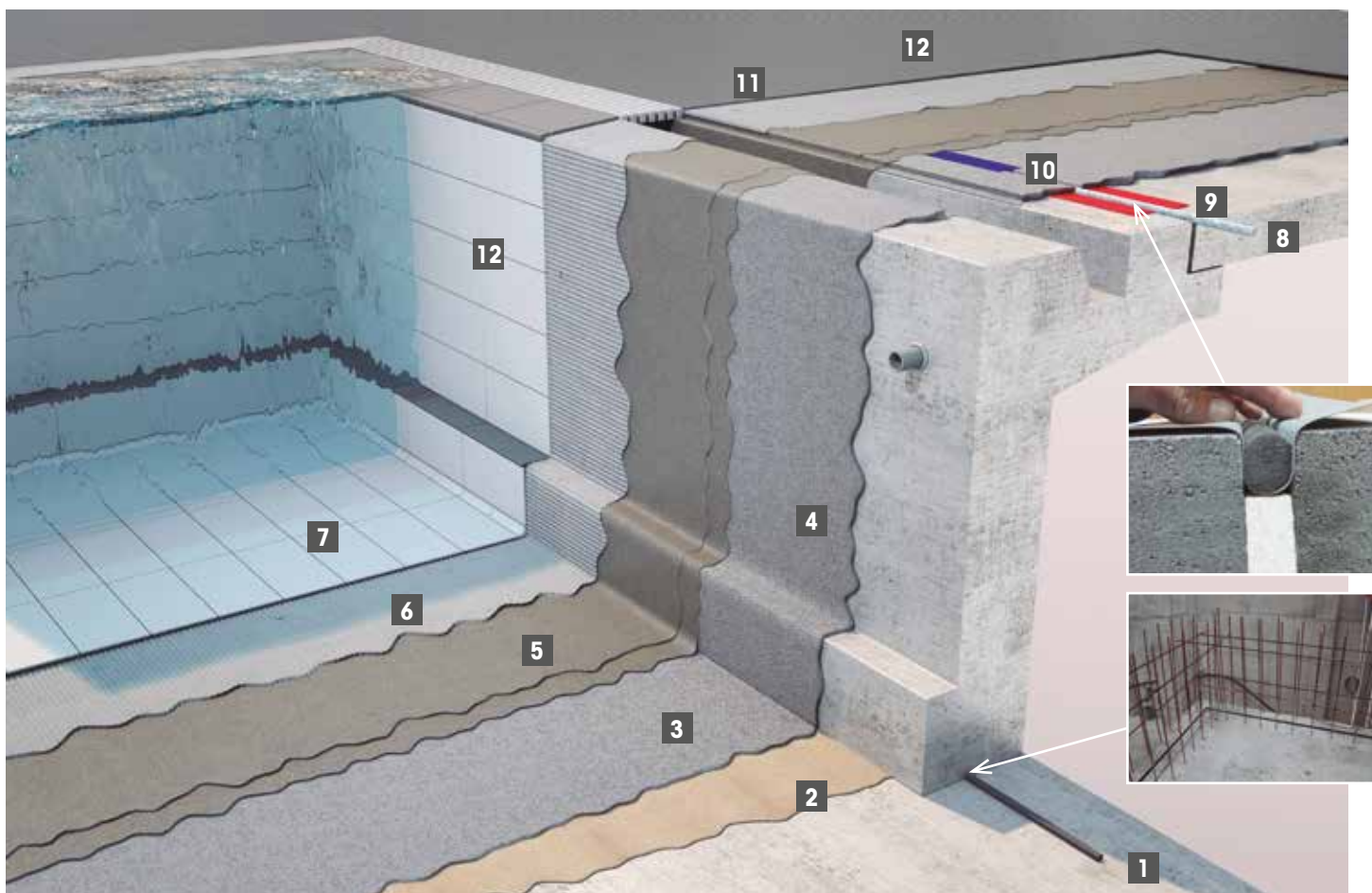

1/ Before undertaking the wall formwork the **FUGA-STOP** concrete joint must be placed in the middle of the reinforced bars. **FUGA-STOP** expands when in contact with water and seals the joint.

2/ Apply bonding paste: 1 part **PRIMFIX** + 1 part portland cement.

3/ While the grout is still fresh, apply **RECCEM PRE-MIX**: quick setting, high resistance screed

4/ Regularize the walls with **FIX-REVOCO**: quick-drying screed for walls.

5/ When the walls and floor are completely dry, apply 2 coats of **HIDROELASTIC**: Elastic, 100% effective waterproofing

6/ After 24 hours have passed, lay the ceramic tiles using **TECNOCOL FLEX** (C2 T S1): an adhesive cement applied over the waterproofing.

7/ After 24 hours have passed, grout using **JUNTATEC** (CG2 W A): mortar resistant to weak acids.

8/ For structural joints that move, place the **FIX-TAPE 170 cm** waterproof band

9/ Place **SELLALASTIC FOAM**: joint filler applied prior to **SELLAFIX**.

10/ Cover the joint with **FIX-BANDA**: self-adhesive strip for expansion joints.

11/ Waterproof the terrace or pool deck with 2 coats of **HIDROELASTIC** (leaving about 4 hours between coats).

12/ After 24 hours, glue the **ROSA GRES** porcelain tile with **TECNOCOL FLEX** (C2 T S1) adhesive.

13/ Finally grout the ceramic tile with **JUNTATEC** (CG2 W A), apart from the expansion joints which should be filled with **SELLAFIX**: elastic, acid proof putty. Perfect for expansion joints in flooring surrounding pool.



Application of **HIDROELASTIC** with a spray gun



Set the slabs with **TECNOCOL FLEX**



Grout using the special joint mortar for pools **JUNTATEC**



Pour **SELLAFIX** to seal the expansion joint

Solution for pools built using the gunite or sprayed concrete technique, allowing the tile to be pasted and grouted in one step.



We achieve speed in its execution and an excellent aesthetic finish as it is a pool's waterproofing product and it is very white and very fine.

1/ The support we find is the sprayed concrete or gunite of the tank itself. As it is waterproofed concrete, it is not essential to apply a waterproofing membrane right afterwards. As gunite pools usually have a good finish on their walls and bottom of the tank, there is no need to make them uniform using screed mortar. Due to this we will go on to:

2/ Install the mosaic using **FIXSET FLEX(C2TE)**: very white tile adhesive, pool water resistant and with fine texture for laying and grouting the tile in one step. With this, we achieve speed of execution and excellent aesthetic finish.

Apply **FIXSET FLEX** with a 6 mm notched trowel and press hard on the tile with a flat spatula.

Make use of the product that comes out of the joints to point the tile using a hard rubber trowel, adding **FIXSE** as needed to finish pointing. After 30 minutes clean up the debris.

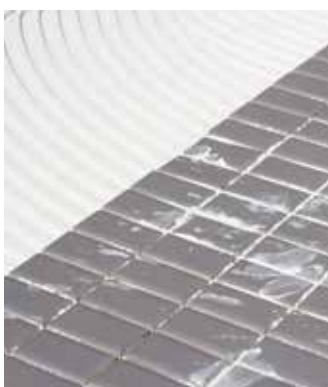

Lay the tile with **FIXSET FLEX**



Grout the tile using **FIXSET FLEX**



First clean with the trowel and then clean with a soft rag



Then clean with a sponge

There are public, municipal, campsite, hotel and residential pools that require an overhaul to correct flaws and to adapt them to new safety regulations. That is why the renovation of old skimmer pools to convert them into infinity pools - much more hygienic and safe - has now become so important. Yet how can this be done quickly, efficiently and economically? By using **System 9 Blocks from Rosa Gres**. With System 9, the overflow channel is quickly made. Here is how to do this step by step.



BEFORE



AFTER

Project:
Renovation of a skimmer pool to convert it into an infinity pool with Ergo S9 blocks. Ridaura Camp site (Llagostera - Girona)

S9 ERGO / S9 FINLANDES - HORYZON / S9 PRESTIGE

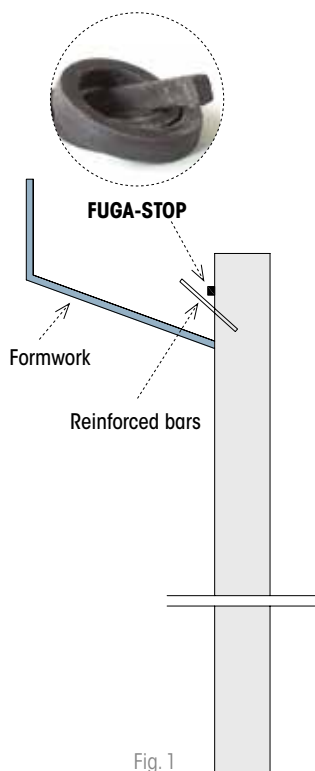

Fig. 1

1 PREPARATION OF THE SURFACE



We remove the old coping. We dig a trench around the tank to pass the pipes of the overflow system. We place the reinforced bars fixed with epoxy resin or chemical wadding.

We place a concrete joint such as **FUGA-STOP**, ensuring that there will be at least 7cm concrete all around it.

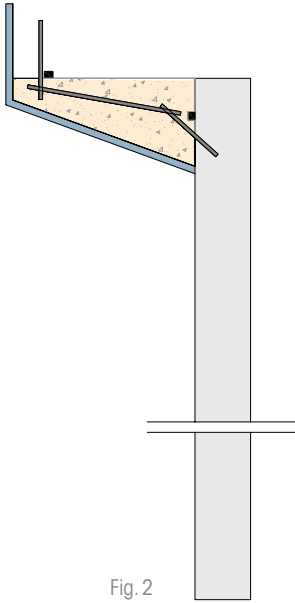

Fig. 2

2 MAKE THE BASE



We set up irons that will build up the board, leaving the reinforced bars for the back gap. We make the base with concrete to be able to place the S9 blocks. Along with the reinforced bars of the back gap we will once again place a concrete joint such as **FUGA-STOP MINI**.



In some cases, when we find there is a sufficiently wide wall, the base will not need to be built, although it is always necessary to make the back gap.

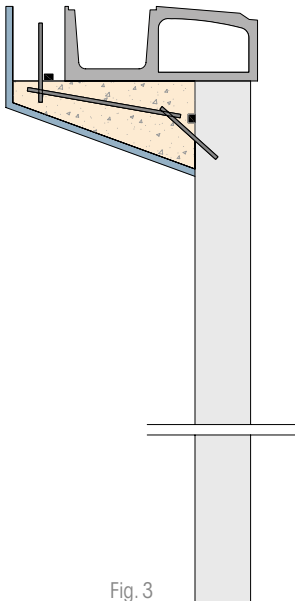

Fig. 3

3 PLACING THE S9 BLOCKS



See details of placing the S9 blocks on page 10

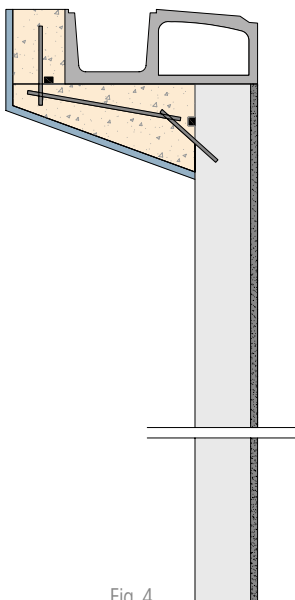

Fig. 4

4 FILLING IN THE BACK GAP



Fill the back gap with concrete, and, if necessary, screed the walls. In the picture you can see how straight the overflowing channel is, which will assist in laying the tiles at the edge of the pool.

RAISING THE BOTTOM OF THE TANK



For comfort, safety and water saving, swimming pools are now shallower than before, so it would probably be a good idea to raise the bottom of the tank when renovating an old pool. It is also good to take advantage of this screeding in order to pass through the pipes of the new drivers.

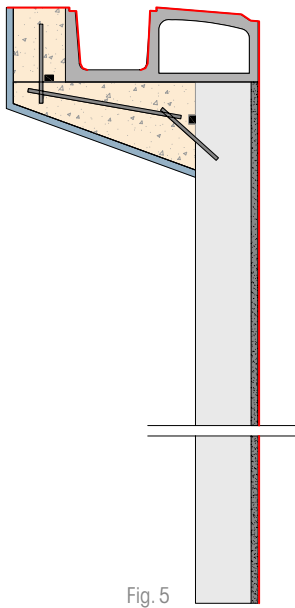

Fig. 5

5 WATERPROOFING



We waterproof the blocks and the tank with an elastic cementitious waterproofing, such as **HIDROELASTIC**. The inside of the overflow channel is waterproofed with a waterproofing, such as **HIDROFIX**.



When the surface is still wet (and we cannot wait for it to dry completely) we will apply a first coat of **HIDROFIX**, reinforcing it with fiberglass mesh, such as **NET-HIDRO 80**. When it dries we will continue with the 2 coats of **HIDROELASTIC**.

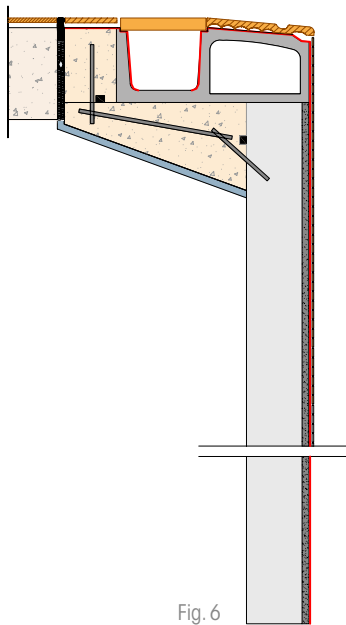

Fig. 6

6 LAYING THE CERAMIC TILES



We will lay the tiles with a glue cement of the type C2 T S1, such as **TECNOCOL FLEX (C2 T S1)**, suitable for gluing porcelain tiles on waterproofing. For more details see page 5.

When we find a pool that has a small pool deck or we seek a cheap solution and that is easy to install, S9 Wiesbaden or S9 Spa blocks are the most suitable solution.

S9 WIESBADEN / S9 SPA

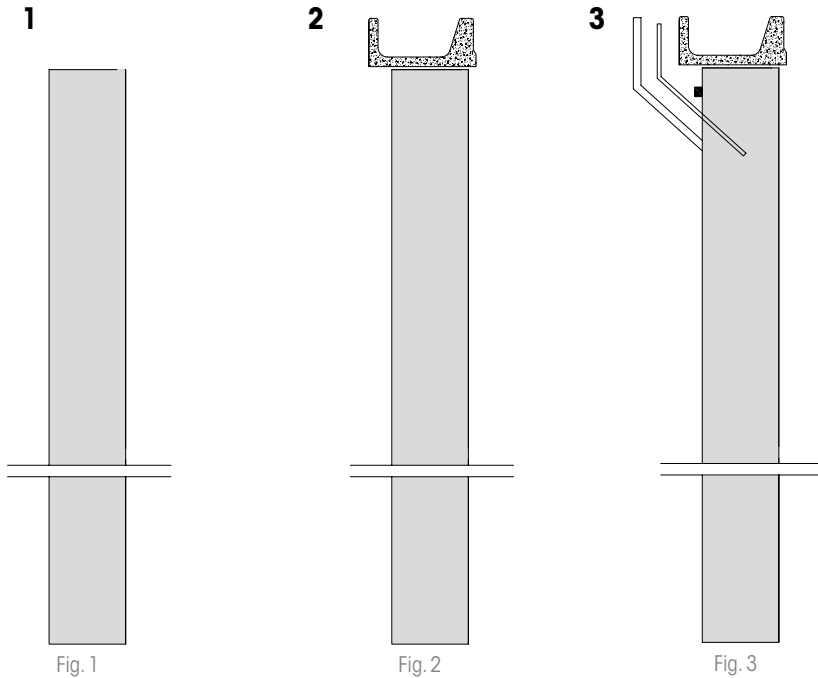

- 1 Remove the old coping and prepare the water collection system.
- 2 Position the S9 blocks with a mortar that has a latex additive such as **PRIMFIX**.
- 3 Anchor the reinforced bars with epoxy resins or chemical wadding. Place the **FUGA-STOP** concrete joint and prepare the formwork.



S9 WIESBADEN System

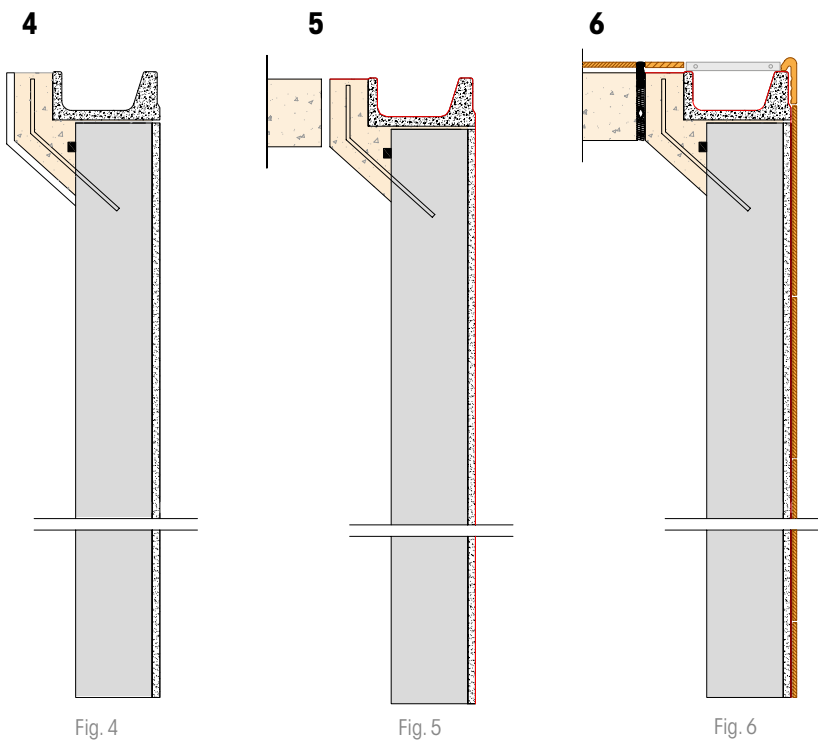

- 4 Fill the back gap with concrete.
- 5 Waterproof the tank and the S9 blocks with **HIDROELASTIC** and overflow channel with **HIDROFIX**.
- 6 Attach the ceramic tile with **TECNOCOL FLEX** (C2 T S1).



S9 SPA System

Solution for re-waterproofing the pool quickly, with low labour cost meaning the entire operation is economical. Allows early re-opening of the pool.



This solution avoids having to take up the old tiles or having to gunite a new tank in the existing tank.

1 / Clean the old tiles with concentrated **GRESNET** acid diluted with water and rinse thoroughly. Then clean with **FIX-SABÓ** degreasing detergent diluted with water. Rinse thoroughly with water and allow to dry completely.

2-3 / Spread a thin layer of **FIXMAX S2** (C2 TE S2) tile adhesive with a flat trowel on the tiles or old tiles, interspersed in the middle with **NET-MORTER-110** fiberglass mesh. Press the mesh and cover with another layer of **FIXMAX-S2**.

4 / After a minimum of 24 hours, re-waterproof the pool that is leaking by applying 2 coats of super-elastic 100% waterproof mortar: **HYDROELASTIC**. Leave 4 hours between coats.

5 / Stick the ceramic tiles with **TECNOCOL FLEX** (C2 T S1): cement for sticking on top of the waterproofing.

6 / Grout with **CERPOXI** (CG2 WA): a joint mortar that is thin, flexible and water-repellent.

7 / In the expansion joints, use **SILICONA NEUTRA**: super-elastic mastic for expansion joints.

8 / To securely anchor ladders or metal bars, use **GROUT S10**: high security anchoring for horizontal casting.



FIXMAX S2 container



First layer of FIXMAX S2



Placement of NET-MORTER-110 mesh



Covering the mesh with FIXMAX S2

Solution to improve the aesthetics and provide a touch of colour and warmth to stainless steel pools.



Stainless steel pools or spas, coated with tiles, give us a wide range of possibilities.

- 1 /** Lightly sand the entire pool with medium grain glass paper; vacuum the walls and bottom from the dust formed and clean with transparent acetone.
- 2 /** Make a prior layer using **FIX AQUA PREMIER + CUARZO NATURAL R**
- 3 /** Apply a layer of **MASTIC MS** with a 3 mm notched trowel and press the pieces hard. **MASTIC MS** (R2 T) is an ultra-elastic adhesive for gluing tiles on top of **STAINLESS STEEL**.
- 4 /** After 24 hours have passed, grout with **CERPOXI** (RG R2 T): high strength epoxy putty with anti-acid resistance, available in 25 colours, for grouting ceramic tiles with maximum durability.



Stainless steel spa



Transparent acetone for cleaning



Ultra-elastic **MASTIC MS** adhesive



Epoxy putty for pointing

Solution to re-coat polyester pools with a tile finish, whether they are new builds or old polyester pools that are damaged.



For both new polyester pools as well as old ones, coating with tiles improves their resistance, aesthetics and gives them a more upscale appearance.

- 1/** Lightly sand the entire pool with a medium grain glass paper; vacuum dust formed and clean with transparent acetone.
- 2/** Glue and grout with **PROFESSIONAL PX**: specially formulated adhesive for gluing and pointing glass or ceramic tiles in pools built with polyester and fiberglass.
- 3/** The stainless steel whirlpool plates with the bubbling air-water exits will be glued with **MASTIC MS**: ultra-elastic adhesive for gluing on top of polyester.

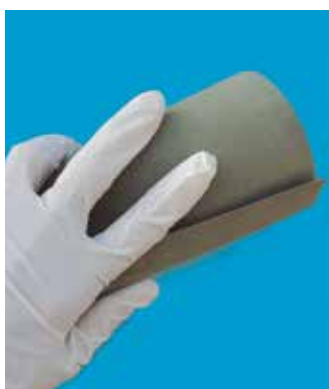

Sand the surface



Vacuum the dust



Clean with transparent acetone



Glue and point the tile with **PROFESSIONAL PX**

Solution for gluing ceramic tiles on glued PVC liners.



To improve the appearance and strength of the pools with a liner attached to the surface, we offer our special adhesives for gluing ceramics to these types of coatings.

1/ PVC Liner: gluing tiles on PVC brings about great technical complexity due to its non absorption and high elasticity. A secure grip is achieved by executing the following steps:

2/ PRIMER FOR ELASTICER: the surface must be dry and clean. Apply the PRIMER on the PVC liner with a clean cloth and then rub vigorously. Leave to dry for 10 minutes.

3/ Apply **ELASTICER** with a 3mm notched trowel, double gluing and pressing hard on the piece. **ELASTICER** (R2 T) is an ultra-elastic adhesive for gluing tiles on top of P.V.C.

4/ Grout with **CERPOXI** (RG R2 T): high strength epoxy putty with anti-acid resistance, available in 25 colours, for grouting ceramic tiles with maximum durability.



PVC sheets.

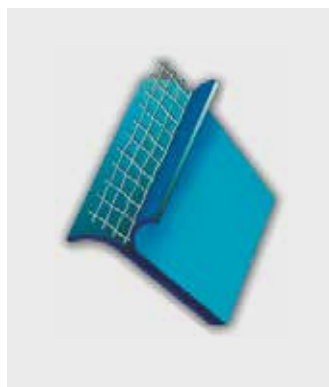

PVC sheet or liner



Priming for **PRIMER** for **ELASTICER**



Ultra-elastic **ELASTICER** adhesive

Terraces are structural elements exposed to outside weather and subject to structural movement, humidity and temperature changes that can be abrupt.

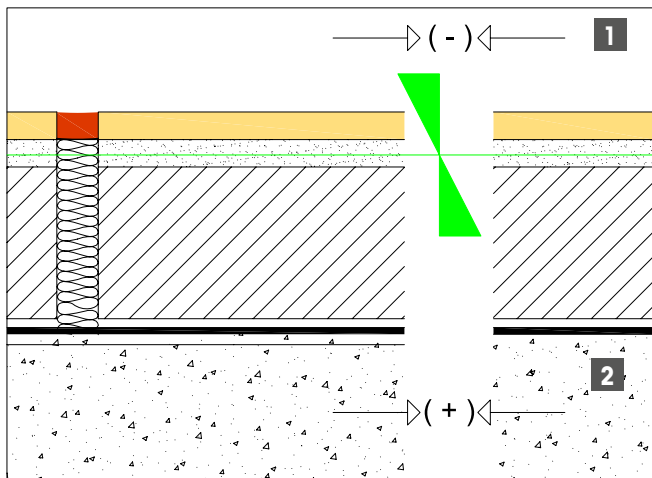

Each material used in the construction has a different expansion coefficient, which causes there to be movements that can create tension.

For example, a 10-foot-long terrace with a heat impact of 50°C (a night thunderstorm on a terrace that has been in the full sun in summer, can have this change in temperature) will be subject to a movement difference between the ceramic surface and the grip base of 4 or 5 mm.

A well-executed terrace, paved with porcelain tiles using mortar, waterproofing, tile adhesives and special exterior grouts withstands the test of time even in extreme climates.

In order to obtain a **flooring that is resistant to frost and thermal impact**, it is necessary to consider four basic aspects of outdoor construction:

- A - Use a porcelain tile that meets the **frost regulations**.
- B - Carry out proper **water drainage**
- C - Respect the **expansion joints**
- D - Use a **fixing and grouting materials** specially for outdoors

Fig. 1 1 less movement 2 greater movement

A - THE ANTI-FROST TILE

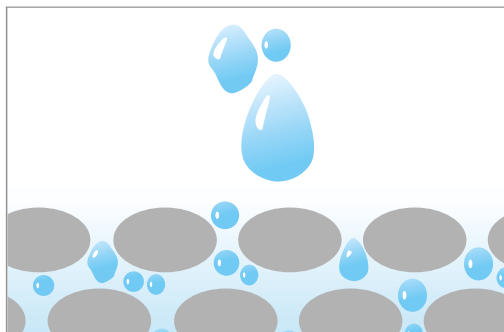

Other ceramic paving tiles: the low compaction of the mass allows the penetration of water into the pores and capillaries, which, upon freezing, may damage the tile.

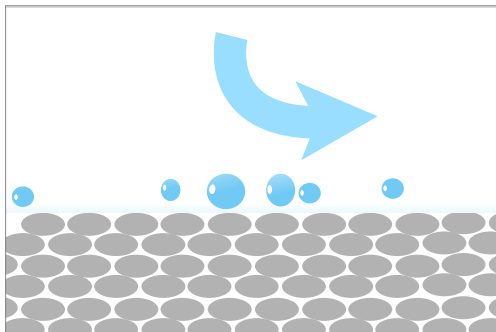

Rosa Gres porcelain tile: the extreme density of porcelain tile prevents water from penetrating the tile through any of its sides.

This meets the ISO 10545-12 standard developed by ISO (International Organisation for Standardisation). The standard covers the test method for determining the behaviour of a ceramic tile when subjected to 100 cycles of freezing / thawing. The test consists of immersing the ceramic tile in water, subjecting it to freeze / thaw between -5° C to +5°C.

Resistance to freeze / thaw is an essential parameter for assessing the durability of a tile designed for outdoor areas.



Rosa Gres porcelain tiles comply with the ISO 10545-12 standard for frost

B - WATER EVACUATION



It is important to drain the water properly to give a natural exit to rain water and to prevent puddles. We recommend the following:

- 1** There must be a minimum slope of 1.5 to 3%
- 2** Place the channels and drains needed. (See p. 34)
- 3** Waterproof and drain the flooring correctly to prevent ground water rising due to capillarity, with the possible migration of salts to the surface.
- 4** Create the movement joints properly and seal them with an impermeable polyurethane mastic, such as **SELLALASTIC**.
- 5** Grout the tiles with a flexible waterproof CG2 class mortar, such as **EUROCOLOR FLEX**.
- 6** Maintenance: ensure that drains are clean and the joints are in good condition.



Make load bearing walls to make the slopes

Terrace with the finished slopes before placing the tiles



Terrace made with **Mistery Blue Stone** 48.8 x79.2, where the slope is seen to the right.

C - JOINTS

PERIMETRAL EXPANSION JOINT

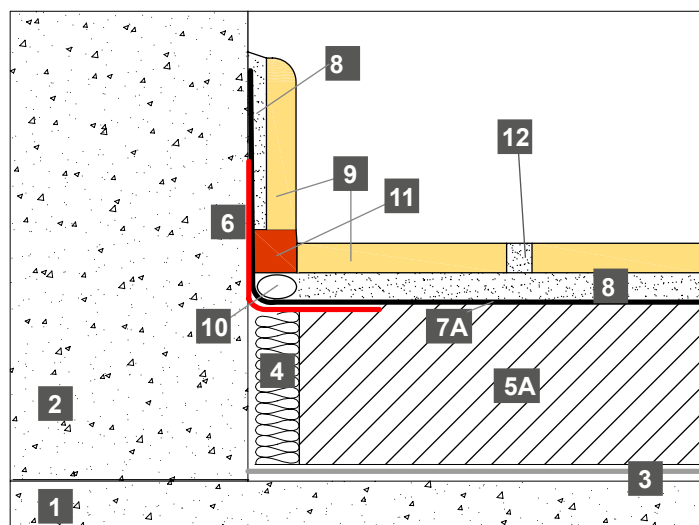

Fig. 2 **Option A** with elastic cementitious waterproofing such as **HIDROELASTIC** (recommended).

Make the entire perimeter of the terrace separate to the side walls of the building, in order to achieve independence of movement between the two.

- 1** Supporting structure (concrete)
- 2** Perimeter fence (concrete or site wall)
- 3** Seal layer
- 4** Expanded polystyrene type filler, porexpan
- 5A** Mortar screed for the slopes, such as **PAVIFORT**
- 5B** Mortar compression layer, such as **PAVIFORT**

EXPANSION JOINTS

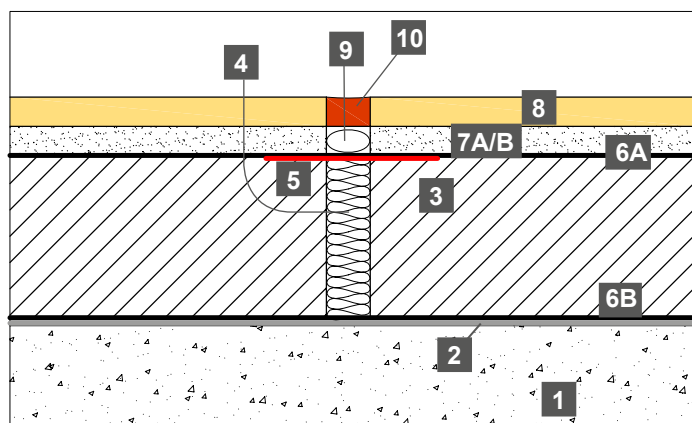

Fig. 4

DESIGN OF THE SURFACES

The layout of expansion joints depends on the size and the floor layout of the coating surfaces

Joints must be made every 16-25 m²

Slab sectors should be shaped as square as possible

The width of the expansion joints must be a minimum of 10 mm

The width of the expansion joints must always be greater than their depth

Expansion joints should be sealed with elastic mastic, such as **SELLALASTIC**

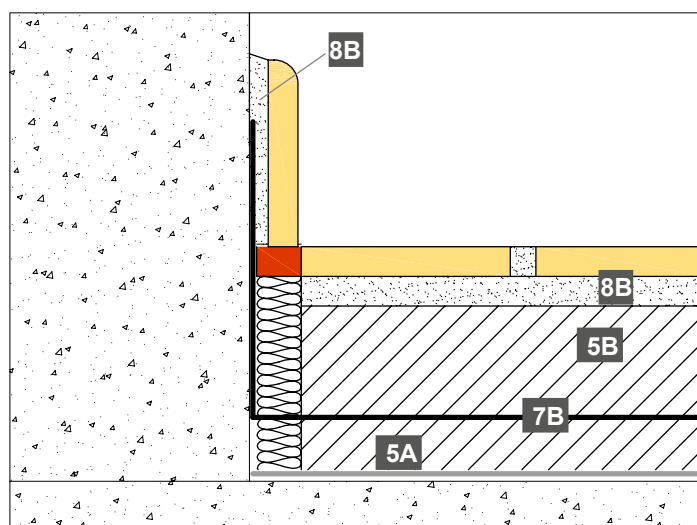

Fig. 3 **Option B** conventional with a waterproofing sheet such as asphalt or similar.

- 6** Self-adhesive sealing band, such as **FIX-BANDA**
- 7A** Elastic cementitious waterproofing membrane, such as **HIDROELASTIC**
- 7B** Waterproofing sheet, such as asphalt material or similar.
- 8A** Special thin coating flexible tile adhesive to glue onto the waterproofing membrane, such as **TECNOCOL FLEX** (C2 T S1)
- 8B** Flexible thin coating tile adhesive to glue tiles outside, such as **TECNOFLEX** (C2 TE S1)
- 9** **ROSA GRES** porcelain tile and plinth.
- 10** Bottom of the expansion joint, such as **SELLALASTIC FOAM**
- 11** Polyurethane elastic putty, such as **SELLALASTIC**
- 12** Mortar for the construction joints, such as **EUROCOLOR FLEX** (CG2 W A)

Create expansion joints every 3-5 metres. They must be flexible, waterproof, well glued and must reach up to sliding surface.

We should also:

- Respect the building's structural joints.
- Avoid surface areas larger than 25 m² or 5 linear metres without releasing tensions.

- 1** Supporting structure (concrete).
- 2** Seal layer (plastic sheet or similar)
- 3** Mortar screed, such as **PAVIFORT**
- 4** Expanded polystyrene type filler, porexpan.
- 5** Self-adhesive sealing band, such as **FIX-BANDA**
- 6A** Elastic cementitious waterproofing membrane, such as **HIDROELASTIC**
- 6B** Waterproofing sheet, such as asphalt material or similar.
- 7A** Special thin coating flexible tile adhesive to glue onto the waterproofing membrane, such as **TECNOCOL FLEX** (C2 T S1)
- 7B** Flexible thin coating tile adhesive to glue tiles outside, such as **TECNOFLEX** (C2 TE S1)
- 8** **ROSA GRES** porcelain tile
- 9** Bottom of the expansion joint, such as **SELLALASTIC FOAM**
- 10** Polyurethane elastic putty, such as **SELLALASTIC**

SLIDING LAYER

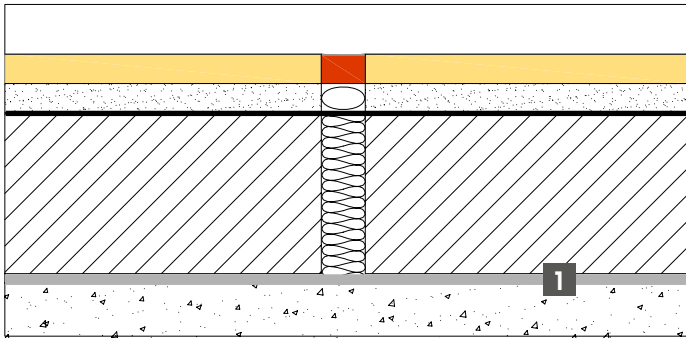

It is advisable to place a sliding layer between the screed mortar and the floor slab when temperature changes are anticipated. In this case, the sliding layer is made using a plastic sheet or similar.

- 1 Sliding layer (plastic sheet or similar) Seal layer (plastic sheet or similar).

Fig. 5

TERRACE FINISHES

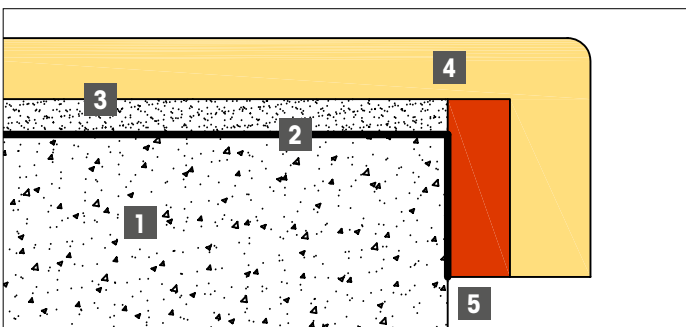

The edges of the pieces should not be glued to the structure on terraces in order to avoid breakage of the tile caused by the expansion of the concrete.

- 1 Concrete or screed mortar
- 2 Waterproofing membrane, such as **HIDROELASTIC**
- 3 Fine layer adhesive cement such as **TECNOCOL FLEX (C2 T S1)**, special to fix on waterproofing membrane
- 4 **ROSA GRES** trim pieces
- 5 Polyurethane elastic putty, such as **SELLALASTIC**

Fig. 6

The **Structural joints** of the floor slab must be respected, as the terrace is the area where most movement is produced.

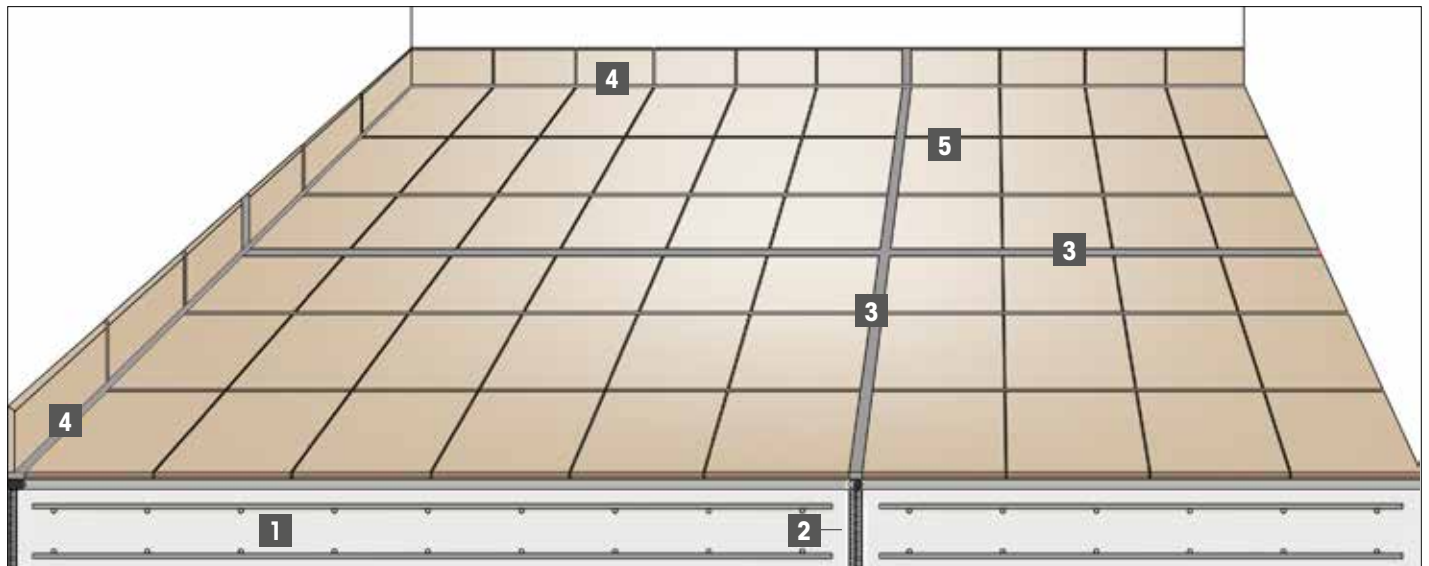

Fig. 7

- 1 Floor slab
- 2 Structural joint
- 3 Expansion joint
- 4 Perimeter joint
- 5 Tiles Joint

D - FIXING AND GROUTING MATERIAL

CHOICE OF TILE ADHESIVE

Use a tile adhesive according to the type of ceramic tile that has enough features for adhesion, flexibility and water resistance, which make it resistant to frost.

Porcelain tiles require a special adhesive cement for this type of tile, which also needs to be flexible to endure the temperature changes of an outdoor terrace. We will use **TECNOFLEX (C2 TE S1)** type cement glue or **TECNOCOL FLEX** type (C2 T S1) (if going on top of a waterproof membrane, such as **HIDROELASTIC**).

GROUTING MATERIAL

The material for grouting the joints should be the same, high adhesion to the ceramic tile and support, waterproof and basically high flexibility. We recommend a minimum joint of 2mm.

In this section we highly recommend the use of joints prepared for this of a CG2 W Ar class such as **EUROCOLOR FLEX**.

INSTALLING

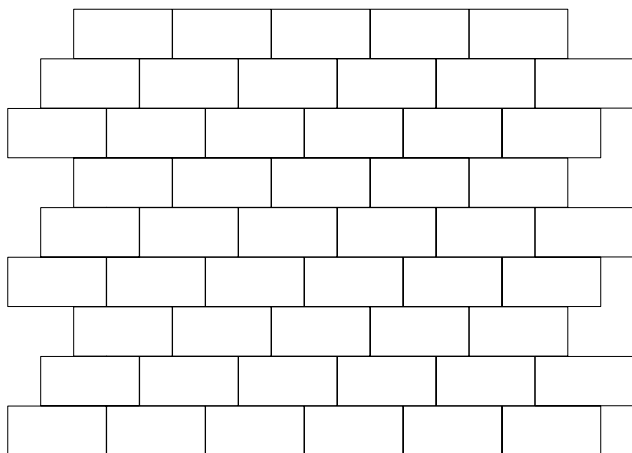

This should always be undertaken in suitable weather conditions, ie:

- Temperatures between +5°C and +30°C
- Do not apply when there is a risk of night frost
- Take care of direct sun during hot periods
- Do not apply when raining

We recommend an on-site layout of the pieces before starting the installation.

The base piece requires a tile-to- tile joint of at least 2mm 3 depending on the format

When using rectangular formats, we recommend to install them with a continuous joint alignment. Should you wish to install a staggered or brick pattern we advise moving them by no more than a third of the tile's length.

Paste the porcelain tile only with cement adhesive that is flexible and suitable for outdoor porcelain tiles of a C2 TE S1 class such as **TECNOFLEX**.

Use the double-spread technique, and press or hit the piece to ensure minimum contact of 90%.

Carefully follow the manufacturer's directions (amount of water in the mixture, stirring time, useful life ...).

When installing with a thicker layer, a class C2 T S1 adhesive such as **TECNOFLEX CAPA GRUESA** must be used.

Before placing the pieces it's important to make sure whether base pieces and special pieces have different thicknesses

When installing the ceramic grids Ref. 245 FL and Ref. 245 CM it is essential to make sure that 100% of the surface settles on the support

CLEANING AT THE END OF THE WORK

- After the placements have been finished, it is essential to remove all traces of grip and grouting material that may remain on the pieces, including surface screen. If not, the dirt will cling to these remains and it will be very difficult to remove with everyday cleaning.
- Do not use products that can damage the joints. If not the the excess grout will dirty the flooring even more.
- Do not use detergent with wax in its formulation, the daily dirt under it will will make it impossible to eliminate it.
- Do not clean with hard water because salts will be deposited on the flooring.
- The use of hot water in the cleaning greatly facilitates the process.

For more information, see pg. 32



ROOFS: HOW TO MAKE AN INVERTED ROOF

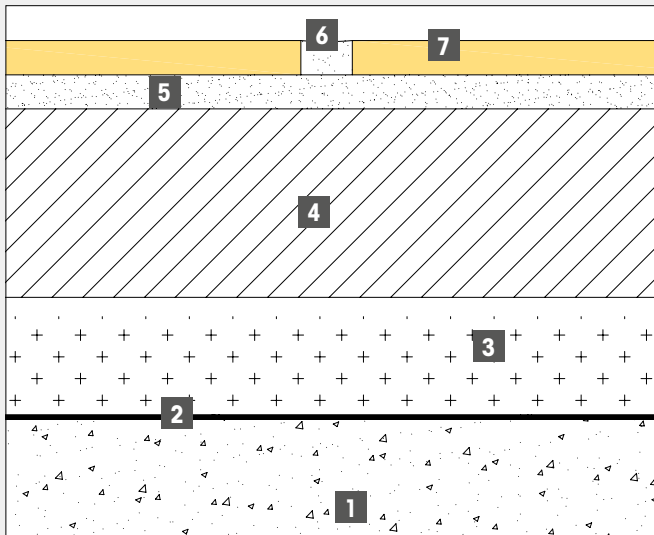

In this type of construction the principal thermal insulation material is applied on top of the weatherproof covering so this is kept at warm temperatures during the winter months and at moderate temperatures during the summer months; the system is also referred to as a 'protected membrane', or 'upside down' roof.

It is a highly recommended system when we have a home under the roof and we want to insulate ourselves from the sun or cold. We save in energy costs of heating and air conditioning and get more comfort.

- 1** Supporting structure (concrete)
- 2** Waterproofing membrane, such as **HIDROELASTIC**
- 3** Thermal insulation, such as extruded polystyrene
- 4** Mortar screed, such as **RECRECEM PRE-MIX**
- 5** Flexible Cement, such as **TECNOFLEX (C2 TE S1)**
- 6** Tiles Joints, such as **EUROCOLOR FLEX (CG2 WA)**
- 7** **ROSA GRES** porcelain tile



Extruded polystyrene



Applying the **RECRECEM PRE-MIX** screed mortar



Filling the joints with **EUROCOLOR FLEX**

Safety in the flooring is a factor that is becoming increasingly important. The need to avoid slips and falls is imperative, especially in places where the floor may be wet (outdoors, swimming pools, etc..) or where there may be fat or other elements that facilitate slippage (industrial kitchens).



ANTI- SLIP REGULATIONS

German test methods are intended for flooring where there is risk of the presence of substances that encourage slippage both with people wearing footwear (DIN 51130) or that are barefoot (DIN 51097).

DIN 51130 NORM FOR SHOE TRAFFIC AREAS

	R9	3° - 10°
	R10	> 10° - 19°
	R11	> 19° - 27°
	R12	> 27° - 35°

Standard for footwear

This test is performed on a device in which the person carrying out the test walks on an inclined slope which varies in angle, wearing footwear with standardised soles. The surface is covered with oil. The angle of inclined slope where they can still walk safely without slipping, is the measurement of the trial.

DIN 51097 NORM FOR BAREFOOT TRAFFIC AREAS

	CLASS A	≥ 12°
	CLASS B	≥ 18°
	CLASS C	≥ 24°

Standard for bare feet

This test is performed on a device in which the person carrying out the test walks on an inclined slope which varies in angle. The surface is covered with tiles to be tested and is continually infused with a soap solution. The angle of inclined slope where they can still be upright without slipping, is the measurement of the trial.

UNE-ENV 12633

	Rd < 15	CLASS 0
	15 < Rd < 35	CLASS 1
	35 < Rd < 45	CLASS 2
	Rd > 45	CLASS 3

Pendulum method

The test involves swinging a friction pendulum with a rubber skate on the end on the surface to be tested. The skate skims the surface along a determined distance (125 mm). Depending on the surface texture, the pendulum breaks to a greater or lesser extent. The decrease in the skate's route read on a calibrated scale is the test result



ASTM C-1028

Dynamometer Method

The test consists of determining the minimum force, tangential to the surface, required to initiate movement over the surface to be tested of a standard slider. This is carried out on dry and wet surfaces. The result is expressed as a coefficient of static friction.

INTERIOR FLOORING

ROSA GRES RECOMMENDS



Inside, although anti-slip requirements are less, they should also be taken into account. Especially in wet areas such as bathrooms or kitchens, where fat or oil may be spilled. On the other hand, we should also not forget the chances of slipping when accessing the interior with wet shoes or when the inside floor is freshly washed.

PUBLIC USE				PRIVATE USE			
Bathrooms		Kitchen / Stairs Slopes > 6%		Others			
UNE ENV 12633	DIN 51130	UNE ENV 12633	DIN 51130	UNE ENV 12633	DIN 51130	UNE ENV 12633	DIN 51130
CLASS 2	R9	CLASS 3	R10	CLASS 1	R9	CLASS 1	R9

TERRACES



Terraces are exposed to the elements. Rain, snow, ice or frost may increase the danger of slipping or falling. This must define the characteristics of the material to be used. It is very important that the following minimum requirements are met: R10 (DIN 51130) and Class 3 (UNE ENV 12633). It is also essential that the surface texture, in addition to its anti-slip properties, should be easy to clean and to keep clean. Anti-slip, Non-slip finishes, UNE ENV 12633 DIN 51130 Bush-hammered and outdoors meet these two requirements.

UNE ENV 12633	DIN 51130
CLASS 3	R10

POOL DECKS



It is essential to have a special anti-slip material for bare feet in the pool deck area. It is of utmost importance to achieve a safe area, avoiding possible slips and falls. In addition to classification 3 according to ENV 12633 of CTE, we propose that the DIN 51097 is also met with a class C.

Pastilla and **Bubbles** finishes are two anti-slip finishes with a special textured surface for areas where people **walk barefoot**. They guarantee a high degree of anti-slip in completely wet areas and even when the user runs. In addition to causing the effect of bare foot grip, they prevent the dreaded "aquaplaning" effect as they channel the water.



UNE ENV 12633	DIN 51097
CLASS 3	CLASS C

CHANGING ROOMS

Changing rooms are the most sensitive area of the pool, as people walk here both bare foot and with footwear, and maximum hygiene and cleanliness is required. We therefore need the flooring to meet the requirements for anti-slip for both people wearing footwear as well as being barefoot.

DRY AREA



UNE ENV 12633
CLASS 2 o 3
ACCORDING TO THE SLOPES
DIN 51097
Minimum CLASS B
DIN 51130
Minimum R10

SHOWERS AND WET AREA

(according to the slopes)



UNE ENV 12633
CLASS 2 o 3
ACCORDING TO THE SLOPES
DIN 51097
CLASS C

Note:

The ANTI-SLIP, NON-SLIP, ABUJARDADO (bush-hammered), OUTFLOOR and OUTDOOR finishes meet the required non-slip regulations. Consult the data sheet for each series.

Whilst the work is being carried out, the flooring becomes dirty due to its anti-slip properties. It is therefore essential to perform a "crash cleaning" at the end of the work.

"CRASH" CLEANING AT THE END OF THE WORK



STEP BY STEP

1/ During installation, we should remove all traces of adhesive material and grouting. It is imperative to clean them "right then" with a damp sponge and not allow them to dry. The rough texture of the anti-slip finish will make it notably more difficult to remove once dry.

2/ We should sweep the entire surface and collect all the construction debris to prevent formation of "smears" on future cleanup actions. We should check that the joints have hardened completely.

3/ We should ensure there are no traces of dry grout or fixing material. In some cases, this cannot be seen as the grouting colour is very similar to that of the ceramic tiles.

If we find that there are still remnants of work materials, and the joints have hardened completely, we should follow these guidelines:

Prepare the **GRESNET** dilution in water. We should start with a very low concentration. We should apply the dilution over a small area, using a hard bristle brush. Whilst wet and without waiting for it to dry, we should rinse with plenty of water to remove all traces.

- For remnants made from epoxy compounds: we should apply a stripper such as **EPOXI CLEANER** from the **FIXCER** brand. We should proceed to carry out a mechanical removal of the dirt after at least one hour has passed. Finally we rinse with plenty of clean water

- It is important to be careful not to attack the joint, as in this case the material from the joint would further dirty the surface of the tiles.

To remove normal daily dirt, the best solution is to use a good cleaning product combined with a correct action.

MAINTENANCE AND DAILY CLEANING



OUR ADVICE

1/ Daily cleaning

Simply use clean water and an alkaline based detergent, such as **FIX-SABÓ**. Avoid the use of detergents that leave a surface layer of wax or grease, since that would enhance the adherence of dirt. They could also adversely affect the anti-slip resistance of the floor.

2/ Stubborn spots and conflictive areas.

We recommend using hot water and cleaning more aggressively with a brushing action. High pressure cleaning equipment or cleaning machines with rotating cylindrical brushes can also be used.

3/ Always with clean water.

For best results, we recommend changing the cleaning water approximately every 15 m² of floor. If we make more use of the water, the dirt in suspension will be deposited on the tiles to be cleaned.

4/ Water alkalinity.

In geographical areas where the water is hard, we recommend installing a water softener. If we do not have one and to prevent lime deposits, collect up the water immediately after cleaning.

Rosa Gres ceramic tiles are resistant to stains according to ISO 10545-14 standards. Tests indicate that at least they should correspond to class 4, where it is easy to remove a stain.

HOW TO TREAT STAINS



STAINS AND ANTI-SLIP FLOORS

Anti-slip floors have rough surfaces and need special attention. When an element that stains penetrates the surface roughness of the piece, this must be removed using the appropriate technique according to what it is made from. First, we should try to dissolve the stain. Later, we should remove it using any mechanical means.

DIFFICULT STAINS

Stains that are especially difficult are those caused by carbon particles, (black-coloured grouts, black paints, graphite pencils and the like). These type of stains can not be dissolved or attacked. They can only be removed by mechanical means.

IDENTIFYING THE NATURE OF THE STAIN

It is very important to identify which element has caused a stain. The stain can be removed if we use the right product. It is not advisable to use products at random. It is very useful to perform a cleaning test on a small area to contrast its action. After using a cleaning product and before using a different one, we must ensure that all traces of the former have been removed.

CARE

When we use a chemical, we should follow the instructions included in the safety data sheet or operating instructions supplied by the manufacturer.

We recommend gloves and goggles to be worn in all cases, and if possible to ventilate the area being treated.

CLEANING AGENT

TYPE OF STAIN	CLEANING AGENT		
	SOFT ACTION	VIGOROUS ACTION	VERY VIGOROUS ACTION
Cement and calcareous residues	Acid-base detergent (Viakal)	Diluted organic acids (vinegar) diluted Gresnet	Phosphoric acid or Gresnet
Rust deposits and stains	Acid-base detergent	Phosphoric acid or Gresnet	
Vegetable and animal fat	Acid-base detergent (Viakal)	Ethyl alcohol	
Vegetable and animal fat	Acid-base detergent	Bicarbonate and water	Trichloroethylene or caustic soda
Tar or bitumen	Detergent in hot water followed by hot water detergent (bleach)	Alcohol or acetone	Trichloroethylene
Paint remnants	Specific dissolvent (turpentine)	Acetone	
Remnants of rubber or latex	Specific dissolvent (trichloroethylene)	Organic solvents	
Beer or wine	Alkaline-based detergent (bleach)	Alcohol or acetone	Caustic soda or potassium bicarbonate
Compounds based on iodine and chromium	Acid-based detergent followed by hydrogen peroxide	Bleach Ammoniac	Caustic soda or potassium bicarbonate
Blood	Hydrogen peroxide	Sodium hypochlorite (bleach)	
Coffee, tea, juice, Coca-Cola, ice-cream, helados	Detergent in hot water followed by hot water or bleach.	Alcohol or acetone Sodium bicarbonate	Caustic soda, potassium hydroxide
Dye or merbromine	Detergent in hot water followed by hot water or bleach.	Alcohol or acetone	

INSTALLING THE WATER COLLECTION GUTTER

First we must consider that what gives resistance to the gutter is its correct installation in the concrete.

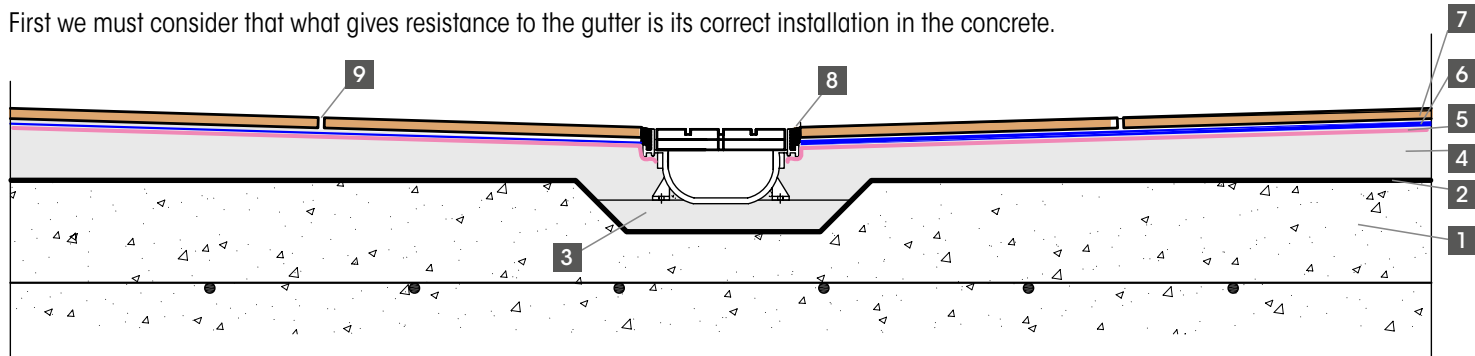

/1/ Reinforced concrete **/2/** Waterproofing sheet such as asphalt material or similar **/3/** Mortar bed, such as **PAVIFORT** **/4/** Mortar screed, such as **PAVIFORT** **/5/** Elastic cementitious waterproofing, such as **HIDROELASTIC** **/6/** Special cement glue to glue on top of the waterproofing, such as **TECNOCOL FLEX (C2 T S1)** **/7/** **ROSA GRES** porcelain tile **/8/** Sealing of the sides of the gutter with polyurethane putty, such as **SELLALASTIC** **/9/** Grouting of the tiles with coloured mortar, such as **EUROCOLOR FLEX (CG2 W A)**



Detail of the channel embedded in mortar



Placing the mortar around the channel



Back of the channel with cut marks and suggested drainage



Detail of the channel with ceramic grille.

1 Make a mortar bed where the channel will be placed whilst wet, in order to ensure complete contact with the base. The lengths of 50 cm channels are designed to be assembled together. They can be glued with PVC glue. It is essential to level the PVC gutters to guarantee that 100% of the surface of the ceramic grid will settle.

2 Channels can be cut into lengths of 10 cm keeping the joints.

3 Fill the sides of the channel with a sufficiently fluid mortar, ensuring that all areas are covered. Separators are placed 13 cm wide in the inside of the channel, before pouring the mortar to prevent it from closing.

4 Place the floor tiles leaving an expansion joint between the flooring and the channel, which is filled with polyurethane putty, such as **SELLALASTIC**.

The flooring must be left 1 to 2 mm higher than the grille. The channel drains at the lower part with an exit that has a 80 mm outer diameter and 75 mm inside one.



View of the PVC gutter positioned during the mortar-filling phase

Solution for re-waterproofing the terrace without using bituminous membranes. The products - polymer, 100% waterproof, elastic and rot-free - are applied on top of the mortar screeds, so that they not only protect the terrace or roof, but also protect the mortars. These are always kept dry and more resistant to freeze-thaw actions.



The floor slab must be made uniform and sloped towards the drain, then the waterproofing is applied to protect the slab and the levelling mortar.

- 1 Floor slab
- 2 Carry out the screed and the slopes with a fast levelling and very strong mortar, such as **PAVIFORT**.
- 3 The drain pipe must be well sealed with **SEAL S10**: ultra-elastic putty to seal the mortar-PVC joint.
- 4 For a proper perimeter expansion joint, place Styrofoam to insulate the the paving of the wall it surrounds.
- 5 Place a butyl self-adhesive strip, such as **FIX-BANDA**, to reinforce the corners.
- 6 When the floor is completely dry, apply 2 coats of super-elastic cementitious waterproofing, such as **HIDROELASTIC**.
- 7 After 24 hours, glue **ROSA GRES** porcelain tiles with a Class C2 T S1 type tile adhesive, such as **TECNOCOL FLEX**, suitable for gluing on top of waterproofing.
- 8 **ROSA GRES** porcelain tile and baseboard.
- 9 Grout the joints with a coloured mortar (0-16 mm), such as **EUROCOLOR FLEX** (CG2 W A)
- 10 Finally fill in the expansion and perimeter joints with a super-elastic polyurethane putty for expansion joints, such as **SELLALASTIC**.



Application of **HIDROELASTIC** waterproofing



Gluing of the tiles with **TECNOCOL FLEX**



EUROCOLOR FLEX adapts to the joints from 0 to 16 mm



Fill in the expansion joints with **SELLALASTIC**



Rosa Gres, S.L.U

Oficina Central - Headquarters - Siège Social - Центральный офис
 Ctra. Sant Cugat km. 3
 08290 Cerdanyola, Barcelona, SPAIN
 Tel. +34 93 586 30 60
 Fax +34 93 586 30 61

Fábrica - Factory - Usine - Фабрика
 Pol. Ind. Mas Vell
 Ramón Sugrañes, 1
 43144 Vallmoll, Tarragona, SPAIN

Ventas: +34 93 586 37 68 / +34 93 586 37 69
 Export Sales: +34 93 586 37 02

info@rosagres.com
 www.rosagres.com



FIXCER PRODUCTS S.A.U

Ctra Sant Cugat Km.3
 08290 Cerdanyola del Vallès
 Barcelona
 Telf.: +34 93 580 2000
 Fax.: +34 93 580 1551
 www.fixcer.com
 fixcer@fixcer.com

July 2017

